

Cuprins

Pistolete pentru sudare WIG

- Pistolete pentru sudare WIG "ABITIG® GRIP", racite cu aer si lichid
ABITIG® GRIP 9 / ABITIG® GRIP 20 Pag. 46–47
- Pistolete pentru sudare WIG "ABITIG® GRIP", racite cu aer si lichid
ABITIG® GRIP 17 / ABITIG® GRIP 18 / ABITIG® GRIP 26 Pag. 48–49
- Pistolete pentru sudare WIG "ABITIG® GRIP", racite cu aer si lichid
ABITIG® GRIP 24 G / ABITIG® GRIP 24 W Pag. 50–51
- Pistolete pentru sudare WIG "ABITIG® GRIP", racite cu lichid
ABITIG® GRIP 12-1 Pag. 52–53
- Pistolete pentru sudare WIG "ABITIG® GRIP", racite cu lichid
ABITIG® GRIP 18 SC Pag. 54–55
- Pistolete pentru sudare WIG "ABITIG® GRIP", racite cu aer si lichid
ABITIG® GRIP 150 / ABITIG® GRIP 260 W Pag. 56–57
- Pistolete pentru sudare WIG "ABITIG® GRIP", racite cu aer si lichid
ABITIG® GRIP 200 / ABITIG® GRIP 450 W / ABITIG® GRIP 450 W SC Pag. 58–59
- Pistolete pentru sudare WIG "ABITIG® GRIP Little", racite cu aer si lichid
ABITIG® GRIP Little 9 / 9 F / 20 / 20 F
ABITIG® GRIP Little 17 / 24 G / 24 W
ABITIG® GRIP Little 150 / 150 F / 260 W Pag. 60–61
- Pistolete pentru sudare WIG "ABITIG®", cu ventil, racire aer
ABITIG® 9 V / ABITIG® 17 V si FV / ABITIG® 26 V si FV Pag. 62
- Pistolete pentru sudare mecanizata WIG, racire aer si lichid
ABITIG® 150 MT / ABITIG® 260 W MT / ABITIG® 200 MT /
ABITIG® 300 W MT / ABITIG® 400 W MT / ABITIG® 500 W MT Pag. 63

Seturi de echipare

- ABITIG® 9 / 12-1 / 17 / 18 / 18 SC / 20 / 24 G / 24 W / 26
ABITIG® 150 / 200 / 260 W / 450 W / 450 W SC Pag. 64

Piese de schimb

- Cablu curent, cablu control, furtune, manere si module Pag. 65–69



Pistolete pentru sudare WIG tip "ABITIG® GRIP" racire aer si lichid

ABITIG® GRIP – solutia completa in domeniul pistoletelor pentru sudare WIG. Aceasta serie reprezinta dezvoltarea logica a seriei ABITIG®, serie care s-a distins prin implementarea designului modular si ergonomia optima.

Pistoletele cu puteri diferite, racite cu aer sau cu lichid, sunt echipate cu un maner ergonomic "GRIP" unic in care pot fi introduse diferite module de comanda si control si un pachet optimizat de cabluri. Toate consumabilele sunt compatibile cu standardul international "SR".

Pachetele de furtune flexibil, sunt disponibile cu conexiuni la masinile de sudare modulare si robuste.

- Un maner ergonomic pentru toate pistoletele ABITIG® GRIP- ofera o prindere deosebita si un sentiment de incredere
- Maner cu comutator si functii de control integrate in maner – individual si ergonomic
- Articulatie scurta cu bila pentru raza optima de indoire si manipulare usoara
- Pachet de furtune usor si flexibil, cu conexiuni modulare la partea spre masina, pentru toate tipurile uzuale de echipamente WIG.
- Consumabile compatibile cu standardele internationale



Sistemul de manere
ABITIG® GRIP - vezi
pag. 68-69.

ABITIG® GRIP 9

Date tehnice (EN 60 974-7):

Racire: aer
Curent: 110 A DC
80 A AC
D.A.: 35 %
Electrod: ø 0.5–1.6 mm

ABITIG® 20

Date tehnice (EN 60 974-7):

Racire: lichid*
Curent: 240 A DC
170 A AC
D.A.: 100 %
Electrod: ø 0.5–3.2 mm

* Presiunea intrare:
Min. 2.5 bar (max. 3.5 bar);
Debitul min. : 0.9 l/min.

Datele tehnice sunt caracteristice pistoletelor cu lungimea de 8,00 m.

Pistolet complet			Corp pistol	
Tip	Racire	Nr. art.	Versiune	Nr. art.
ABITIG® GRIP 9	aer	vezi comentarii**	Standard	712.5020
ABITIG® GRIP 9 F	aer	vezi comentarii**	Flexibil	712.5030
ABITIG® GRIP 20	lichid	vezi comentarii**	Standard	712.3020
ABITIG® GRIP 20 F***	lichid	vezi comentarii**	Flexibil	712.3020



** datorita diferitelor tipuri de conexiuni la masina, nu putem preciza aici un numar de articol pentru pistolete. Va rugam consultati catalogul pistolete WIG complete existent in sectiunea download la adresa: www.binzel-abicor.ro.

*** de asemenea la cerere, 30 mm si 65 mm

ABITIG® GRIP 9, ABITIG® GRIP 20



Consumabile



			
Capac (10 buc.)	scurt	mediu	lung
	701.0240 / 41V33	701.0244 / 41V35	701.0247 / 41V24

			
	25 mm	25 mm	40 mm
Penseta (10 buc.)	Versiune standard	Versiune alama	Versiune "Jumbo"
Ø 0.5 mm	701.0249 / 13N20	-	701.1225 / 13N20L
Ø 1.0 mm	701.0250 / 13N21	701.0250 / 13N21	701.1226 / 13N21L
Ø 1.2 mm	701.0254 / -	-	-
Ø 1.6 mm	701.0251 / 13N22	701.0251 / 13N22	701.1227 / 13N22L
Ø 2.0 mm	701.0255 / -	-	-
Ø 2.4 mm	701.0252 / 13N23	701.0252 / 13N23	701.1228 / 13N23L
Ø 3.2 mm	701.0278 / 13N29	701.0253 / 13N24	701.1229 / 13N24L

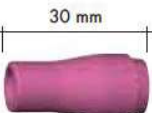
		
Inel izolator / Adaptor	Inel izolator (10 buc.)	Adaptor (5 buc.)
	702.0055 / 598882	701.1234 / 54N63-20

			
Portpenseta	Standard (10 buc.)	Standard cu lentila gaz (10 buc.)	"Jumbo" cu lentila gaz (5 buc.)
Ø 0.5-1.0 mm	701.0275 / 13N26	701.0301 / 45V42	701.1230 / 45V0204S
Ø 1.2 mm	701.0279 / -	701.0313 / -	-
Ø 1.6 mm	701.0276 / 13N27	701.0307 / 45V43	701.1231 / 45V116S
Ø 2.0 mm	701.0280 / -	701.0315 / -	-
Ø 2.4 mm	701.0277 / 13N28	701.0309 / 45V44	701.1232 / 45V64S
Ø 3.2 mm	701.0278 / 13N29	701.0311 / 45V45	701.1233 / 995795S

			
	30 mm	25.5 mm	48 mm
Duza gaz, Ceramica (10 buc.)	Standard	Standard pentru lentila gaz	"Jumbo" pentru lentila gaz
Gr. 4 Ø 6.5 mm	701.0281 / 13N08	701.0317 / 53N58	-
Gr. 5 Ø 8.0 mm	701.0282 / 13N09	701.0318 / 53N59	-
Gr. 6 Ø 9.5 mm	701.0283 / 13N10	701.0319 / 53N60	701.1199 / 57N75
Gr. 7 Ø 11.0 mm	701.0284 / 13N11	701.0320 / 53N61	-
Gr. 8 Ø 12.5 mm	701.0285 / 13N12	-	701.1200 / 57N74
Gr. 10 Ø 16.0 mm	701.0286 / 13N13	-	701.1201 / 53N88
Gr. 12	-	-	701.1121 / 53N87

		
	X1	34 mm
Duza gaz, Ceramica (10 buc.)	Standard	"Jumbo" pentru lentila gaz****
Gr. 4 Ø 6.5 mm 48 mm	701.0289 / 796F71	701.1202 / 53N89
Gr. 5 Ø 8.0 mm 48 mm	701.0290 / 796F72	
Gr. 6 Ø 9.5 mm 48 mm	701.0291 / 796F73	
Gr. 4 Ø 6.5 mm 63 mm	701.0293 / 796F75	
Gr. 5 Ø 8.0 mm 63 mm	701.0294 / 796F76	
Gr. 4 Ø 6.5 mm 89 mm	701.0296 / 796F79	

**** nerecomandate la amorsarea cu inalta frecventa

WIG

Pistolete pentru sudare WIG tip "ABITIG® GRIP" racire aer si lichid



Sistemul de manere
ABITIG® GRIP – vezi
pag. 68-69.

- Un maner ergonomic pentru toate tipurile de pistolete ABITIG® GRIP
- Maner cu comutator si functii de control integrate – individual si ergonomic
- Articulatie scurta cu bila pentru raza optima de indoire si manipulare usoara
- Pachet de furtune usor si flexibil, cu conectarea modulara la partea spre masina, pentru toate tipurile uzuale de echipamente WIG.
- Consumabile compatibile cu standardele internationale.

ABITIG® GRIP 17

Date tehnice (EN 60 974-7):

Racire:	aer
Curent:	140 A DC 100 A AC
D.A.:	35 %
Electrod:	ø 0.5–2.4 mm

ABITIG® GRIP 18

Date tehnice (EN 60 974-7):

Racire:	lichid*
Curent:	320 A DC 230 A AC
D.A.:	100 %
Electrod:	ø 0.5–4.0 mm

* Presiunea:
Min. 2.5 bar (max. 3.5 bar);
Debitul min. : 0.7 l/min.

ABITIG® GRIP 26

Date tehnice (EN 60 974-7):

Racire:	aer
Curent:	180 A DC 130 A AC
D.A.:	35 %
Electrod:	ø 0.5–4.0 mm

Datele tehnice sunt caracteristice pistolotelor
cu lungimea de 8,00 m.

Pistolet complet Tip	Racire	Nr. art.	Corp pistolot	
			Versiune	Nr. art.
ABITIG® GRIP 17	aer	vezi comentarii**	Standard	712.1020
ABITIG® GRIP 17 F	aer	vezi comentarii**	Flexibil	712.1030
ABITIG® GRIP 18	lichid	vezi comentarii**	Standard	712.2020
ABITIG® GRIP 18 F	lichid	vezi comentarii**	Flexibil	712.2020
ABITIG® 18 K	lichid	vezi comentarii**	Scurt	712.2230
ABITIG® 26	aer	vezi comentarii**	Standard	712.4020
ABITIG® 26 F	aer	vezi comentarii**	Flexibil	712.4030
ABITIG® 26 K	aer	vezi comentarii**	Scurt	712.4230

** datorita diferitelor tipuri de conexiuni la masina, nu putem preciza aici un numar de articol pentru pistolete. Va rugam consultati catalogul pistolote WIG complete existent in sectiunea download la adresa: www.binzel-abicor.ro.

ABITIG® GRIP 17, ABITIG® GRIP 18, ABITIG® GRIP 26

Consumabile



Capac (5 buc.)	scurt 712.1053	lung 712.1051
----------------	-------------------	------------------



Penseta (10 buc.)	(50 mm)	(52 mm)
Ø 0.5 mm	702.0005 / 10N21	701.0169 / 10N21D
Ø 1.0 mm	702.0006 / 10N22	701.0171 / 10N22D
Ø 1.2 mm	702.0007 / -	701.0170 / -
Ø 1.6 mm	702.0008 / 10N23	701.0172 / 10N23D
Ø 2.0 mm	702.0012 / -	701.0176 / -
Ø 2.4 mm	702.0009 / 10N24	701.0173 / 10N24D
Ø 3.2 mm	702.0010 / 10N25	701.0174 / 10N25D
Ø 4.0 mm	702.0011 / 54N20	701.0175 / 54N20D



Inel izolator / Adaptor	Inel izolator (10 buc.) 703.0012 / 18CG	Adaptor (10 buc.) 701.0130 / 54N01	Adaptor (5 buc.) 701.1122 / 54N63
-------------------------	--	---------------------------------------	--------------------------------------



Portpenseta	Standard (10 buc.)	Standard cu lentila gaz (10 buc.)	"Jumbo" cu lentila gaz (5 buc.)
Ø 0.5-1.2 mm	701.0190 / 10N30	701.0201 / 45V24	-
Ø 1.6 mm	701.0191 / 10N31	701.0203 / 45V25	701.1116 / 45V116
Ø 2.0 mm	701.0196 / 10N32	701.0207 / 45V26	-
Ø 2.4 mm	701.0196 / 10N32	701.0207 / 45V26	701.1117 / 45V64
Ø 3.2 mm	701.0197 / 10N28	701.0209 / 45V27	701.1118 / 995795
Ø 4.0 mm	701.0198 / 406488	701.0211 / 45V28	701.1208 / 45V63

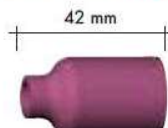
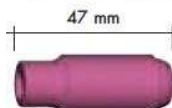

Duza gaz, Ceramica (10 buc.)	Standard	Standard pentru lentila gaz	"Jumbo" pentru lentila gaz
Gr. 4 Ø 6.5 mm	701.0107 / 10N50	701.0420 / 54N18	-
Gr. 5 Ø 8.0 mm	701.0108 / 10N49	701.0421 / 54N17	-
Gr. 6 Ø 9.5 mm	701.0109 / 10N48	701.0422 / 54N16	701.1199 / 57N75
Gr. 7 Ø 11.0 mm	701.0110 / 10N47	701.0423 / 54N15	-
Gr. 8 Ø 12.5 mm	701.0111 / 10N46	701.0424 / 54N14	701.1200 / 57N74
Gr. 10 Ø 16.0 mm	701.0113 / 10N45	-	701.1201 / 53N88
Gr. 12 Ø 19.5 mm	701.0114 / 10N44***	701.0426 / 54N19	701.1121 / 53N87

***50 mm lungime

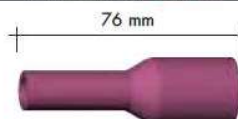

Duza gaz, Ceramica (10 buc.)	Standard	Standard pentru lentila gaz	"Jumbo" pentru lentila gaz****
Gr. 5 Ø 8.0 mm	701.0115 / 10N49L	701.0427 / 54N17L	-
Gr. 6 Ø 9.5 mm	701.0116 / 10N48L	701.0428 / 54N16L	-
Gr. 7 Ø 11.0 mm	701.0117 / 10N47L	701.0429 / 54N15L	-
Ø 24.0 mm	-	-	701.1202 / 53N89

**** nerecomandate la amorsarea cu inalta frecventa

WIG

Pistolete pentru sudare WIG tip "ABITIG® GRIP" racire aer si lichid

- Un maner ergonomic pentru toate tipurile de pistolete ABITIG® GRIP- ofera o prindere deosebita si un sentiment de incredere.
- Maner cu comutator si functii de control integrate – individual si ergonomic.
- Articulație scurta cu bila pentru raza optima de indoire si manipulare usoara
- Pachet de furtune usor si flexibil, cu conexiuni modulare la partea spre masina, pentru toate tipurile uzuale de echipamente WIG.
- Consumabile compatibile cu standardele internationale.



Sistemul de manere
ABITIG® GRIP – vezi
pag. 68-69.

ABITIG® GRIP 24 G

Date tehnice (EN 60 974-7):

Racire: aer
Curent: 110 A DC
80 A AC
D.A.: 35 %
Electrod: ø 0.5–1.6 mm

ABITIG® GRIP 24 W

Date tehnice (EN 60 974-7):

Racire: lichid*
Curent: 140 A DC
100 A AC
D.A.: 100 %
Electrod: ø 0.5–2.4 mm

* Presiunea:
Min. 2.5 bar (max. 3.5 bar);
Debitul min. : 0.7 l/min.

Datele tehnice sunt caracteristice pistoletelor cu lungimea de 8,00 m.

Pistolete complete

Tip	Racire	Nr. art.	Corp pistol	
			Versiune	Nr. art.
ABITIG® GRIP 24 G	aer	vezi comentarii**	Standard	712.7020
ABITIG® GRIP 24 W	lichid	vezi comentarii**	Standard	712.7120

**datorita diferitelor tipuri de conexiuni la masina, nu putem preciza aici un numar de articol pentru pistolete. Va rugam consultati catalogul pistolete WIG complete existent in sectiunea download la adresa: www.binzel-abicor.ro.

ABITIG® GRIP 24 G, ABITIG® GRIP 24 W

Consumabile



Bucsa izolatoare / Izolator	Bucsa izolatoare (10 buc.)	Izolator pentru lentila gaz (10 buc.)
	701.0458 / 53N22	701.0459 / 53N66

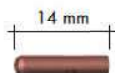

Penseta (10 buc.)	Standard	Standard pentru lentila gaz
Ø 0.5 mm	701.0452 / 53N15	701.0461 / -
Ø 1.0 mm	701.0453 / 53N16	701.0462 / 53N63
Ø 1.2 mm	701.0455 / -	701.0464 / -
Ø 1.6 mm	701.0454 / 53N14	701.0463 / 54N64
Ø 2.0 mm	701.0456 / -	701.0466 / -
Ø 2.4 mm	701.0457 / 24C332	701.0465 / 24GLC332



Portpenseta (10 buc.)	Standard	Standard cu lentila gaz
Ø 0.5 mm	701.0479 / 53N17	701.0301 / 45V41
Ø 1.0 mm	701.0480 / 53N18	701.0301 / 45V42
Ø 1.2 mm	701.0483 / -	701.0313 / -
Ø 1.6 mm	701.0481 / 53N19	701.0307 / 45V43
Ø 2.0 mm	701.0484 / -	701.0315 / -
Ø 2.4 mm	701.0482 / 24CB332	701.0309 / 45V44



Duza gaz, Ceramica (10 buc.)	Standard	Standard pentru lentila gaz
Gr. 4 Ø 6.5 mm	701.0468 / 53N24	701.0317 / 53N58
Gr. 5 Ø 8.0 mm	701.0469 / 53N25	701.0318 / 53N59
Gr. 6 Ø 9.5 mm	701.0470 / 53N27	701.0319 / 53N60
Gr. 7 Ø 11.0 mm	-	701.0320 / 53N61

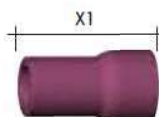

Duza gaz, Ceramica (10 buc.)	Standard
Gr. 4L Ø 6.5 mm 29.0 mm	701.0471 / 53N28
Gr. 6L Ø 9.5 mm 29.0 mm	701.0472 / 53N26
Gr. 4L Ø 6.5 mm 62.5 mm	701.0473 / 53N24L
Gr. 5L Ø 8.0 mm 91.5 mm	701.0474 / 53N27L

WIG

Pistolete pentru sudare WIG tip "ABITIG® GRIP" racire lichid

- Un maner ergonomic pentru toate tipurile de pistolete ABITIG® GRIP- ofera o prindere deosebita si un sentiment de incredere.
- Maner cu comutator si functii de control integrate – individual si ergonomic.
- Articulație scurta cu bila pentru raza optima de indoire si manipulare usoara
- Pachet de furtune usor si flexibil, cu conexiuni modulare la partea spre masina, pentru toate tipurile uzuale de echipamente WIG.
- Consumabile compatibile cu standardele internationale.



Sistemul de manere
ABITIG® GRIP – vezi
pag. 68-69.

ABITIG® GRIP 12-1

Date tehnice (EN 60 974-7):

Racire: lichid*
Curent: 350 A DC
250 A AC
D.A.: 100 %
Electrod: ø 1.6–4.0 mm

* Presiunea:
Min. 2.5 bar (max. 3.5 bar);
Debitul min. : 0.7 l/min.

Datele tehnice sunt caracteristice pistolotelor cu lungimea de 8,00 m.

Pistolet complet

Tip	Racire	Nr. art.	Corp pistolot	
			Versiune	Nr. art.
ABITIG® GRIP 12-1	lichid	vezi comentarii**	Standard	712.0020

**datorita diferitelor tipuri de conexiuni la masina, nu putem preciza aici un numar de articol pentru pistolete. Va rugam consultati catalogul pistolote WIG complete existent in sectiunea download la adresa: www.binzel-abicor.ro.

ABITIG® GRIP 12-1

Consumabile



Capac	scurt	lung
	712.0053	712.0051



Penseta (10 buc.)	Standard
Ø 1.6 mm	712.0062
Ø 2.4 mm	712.0063
Ø 3.2 mm	712.0064
Ø 4.0 mm	712.0065



Portpenseta (10 buc.)	Standard	Standard cu lentila gaz
Ø 1.6 mm	712.0072	712.0101
Ø 2.4 mm	712.0073	712.0102
Ø 3.2 mm	712.0074	712.0103
Ø 4.0 mm	712.0075	712.0104

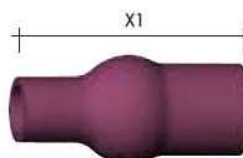

Duza gaz, Ceramica			Standard
(10 buc.)			
		X1	
Gr. 4	Ø 6.5 mm	43 mm	704.0046 / 130.00
Gr. 5	Ø 8.0 mm	43 mm	704.0047 / 131.00
Gr. 6	Ø 9.5 mm	43 mm	704.0048 / 132.00
Gr. 7	Ø 11.0 mm	43 mm	704.0049 / 133.00
Gr. 8	Ø 12.5 mm	43 mm	704.0050 / 134.00
Gr. 9	Ø 14.5 mm	43 mm	704.0051 / 135.00
Gr. 10	Ø 16.0 mm	43 mm	704.0052 / 136.00
Gr. 11	Ø 17.5 mm	48 mm	704.0053 / 137.00

WIG

Pistolete pentru sudare WIG tip "ABITIG® GRIP" racire lichid

- Un maner ergonomic pentru toate tipurile de pistolete ABITIG® GRIP- ofera o prindere deosebita si un sentiment de incredere.
- Maner cu comutator si functii de control integrate – individual si ergonomic.
- Articulație scurta cu bila pentru raza optima de indoire si manipulare usoara
- Pachet de furtune usor si flexibil, cu conexiuni modulare la partea spre masina, pentru toate tipurile uzuale de echipamente WIG.
- Consumabile compatibile cu standardele internationale.



Sistemul de manere
ABITIG® GRIP – vezi
pag. 68-69.

ABITIG® GRIP 18 SC

Date tehnice (EN 60 974-7):

Racire: lichid*
Curent: 400 A DC
280 A AC
D.A.: 100 %
Electrod: ø 0.5–4.8 mm

* Presiunea:
Min. 2.5 bar (max. 3.5 bar);
Debitul min. : 0.9 l/min.

Datele tehnice sunt caracteristice pistoletelor
cu lungimea de 8,00 m.

Pistolet complet

Tip	Racire	Nr. art.	Corp pistol	
			Versiune	Nr. art.
ABITIG® GRIP 18 SC	lichid	vezi comentarii**	Standard	712.6020

**datorita diferitelor tipuri de conexiuni la masina, nu putem preciza aici un numar de articol pentru pistolete. Va rugam consultati catalogul pistolete WIG complete existent in sectiunea download la adresa: www.binzel-abicor.ro.

ABITIG® GRIP 18 SC

Consumabile



Capac (5 buc.)	scurt	lung
	712.1053	712.1051

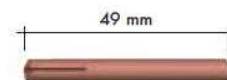
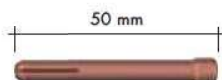

Penseta (10 buc.)	Standard	HL
Ø 0.5 mm	702.0005 / 10N21	-
Ø 1.0 mm	702.0006 / 10N22	-
Ø 1.6 mm	702.0008 / 10N23	-
Ø 2.4 mm	702.0009 / 10N24	-
Ø 3.2 mm	702.0010 / 10N25	712.6064 / 10N25HD
Ø 4.0 mm	-	712.6065 / 54N20HD
Ø 4.8 mm	-	712.6066 / 18C36



Inel izolator	Inel izolator (5 buc.)
	712.6043 / 18NG



Portpenseta (10 buc.)	Standard	Standard cu lentila gaz	HL
Ø 0.5 mm	-	712.6099 / 18GL02	-
Ø 1.0 mm	-	712.6100 / 18GL04	-
Ø 1.6 mm	-	712.6101 / 18GL16	-
Ø 2.4 mm	-	712.6102 / 18GL32	-
Ø 3.2 mm	-	712.6103 / 18GL18	-
Ø 4.0 mm	-	712.6104 / 18GL53	-
Ø 4.8 mm	-	712.6105 / 18GL36	-
Ø 0.5-3.2 mm	712.6074 / NCB-53	-	-
Ø 3.2-4.8 mm	-	-	712.6076 / NCB-36



Duza gaz, Ceramica (10 buc.)	Standard	Standard
Gr. 4 Ø 6.5 mm	701.0420 / 54N18	-
Gr. 5 Ø 8.0 mm	701.0421 / 54N17	701.0427 / 54N17L
Gr. 6 Ø 9.5 mm	701.0422 / 54N16	701.0428 / 54N16L
Gr. 7 Ø 11.0 mm	701.0423 / 54N15	701.0429 / 54N15L
Gr. 8 Ø 12.5 mm	701.0424 / 54N14	-
Gr. 12 Ø 19.5 mm	701.0426 / 54N19	-

WIG

Pistolete pentru sudare WIG tip "ABITIG® GRIP" racire aer si lichid

Seria ABITIG® GRIP "ABICOR BINZEL-Style", racire cu aer si lichid, ofera varful performantei printr-un pachet usor si confortabil. sistemul de racire garanteaza durata mare de utilizare si permite folosirea electrozilor de Wolfram scurți printr-o disipare optimizata a caldurii.

Reducerea cantitatii de consumabile la numai trei componente (capac, portelectrod / portelectrod cu lentila gaz si duza gaz filetata) simplifica utilizarea si ajuta la reducerea costurilor aferente depozitarii.

Designul inovativ previne transferul caldurii de la duza de gaz la corpul pistolului. Acesta protejeaza pistolul, mareste durata de utilizare si de asemenea reduce costurile de intretinere.

Manerele inteligente ABITIG® GRIP ofera un confort marit datorita introducerii a numeroase elemente de comanda si control. Mai mult, manerele sunt protejate impotriva varfurilor de inalta frecventa (HF).

- Un maner ergonomic pentru toate pistoletele ABITIG® GRIP- ofera o prindere deosebita si un sentiment de incredere.
- Maner cu comutator si functii de control integrate – individual si ergonomic.
- Articulație scurta cu bila pentru raza optima de indoire si manipulare usoara.
- Pachet de furtune usor si flexibil, cu conexiuni modulare la partea spre masina, pentru toate tipurile uzuale de echipamente WIG.
- Reducerea costurilor cu depozitarea – numai 3 consumabile.



Sistemul de manere
ABITIG® GRIP – vezi
pag. 68-69.

ABITIG® GRIP 150 / ABITIG® GRIP 150 F

**Date tehnice (EN 60 974-7)
(cu duza de gaz 36 mm):**

Racire: aer
Curent: 150 A DC
105 A AC
D.A.: 35 %
Electrod: ø 1.0–2.4 mm

ABITIG® GRIP 260 W

Date tehnice (EN 60 974-7):

Racire: lichid*
Curent: 280 A DC / 260 A DC
195 A AC / 185 A AC
D.A.: 60 % / 100 %
Electrod: ø 1.0–3.2 mm

* Presiunea:
Min. 2.5 bar (max. 3.5 bar);
Debitul min. : 0.7 l/min.

Datele tehnice sunt caracteristice pistolului cu lungimea de 8,00 m.



Pistol complet Tip	Racire	Nr. art.	Corp pistol	
			Versiune	Nr. art.
ABITIG® GRIP 150	aer	vezi comentarii**	Standard	776.0010
ABITIG® GRIP 150 F	aer	vezi comentarii**	Flexibil	776.0130
ABITIG® GRIP 260 W	lichid	vezi comentarii**	Standard	777.0010



**datorita diferitelor tipuri de conexiuni la masina, nu putem preciza aici un numar de articol pentru pistolete. Va rugam consultati catalogul pistolului WIG complete existent in sectiunea download la adresa: www.binzel-abicor.ro.

ABITIG® GRIP 150, ABITIG® GRIP 260 W





Consumabile

			
Capac	scurt	mediu	lung
	776.0053	771.0051	776.0051

			
	35 mm	33 mm	33 mm
Portelectrod / Portelectrod cu lentila	Portelectrod (5 buc.)	Portelectrod cu lentila	Portelectrod cu lentila
Ø 1.0 mm	776.0061	776.0171	776.0171
Ø 1.6 mm	776.0062	776.0172	776.0172
Ø 2.0 mm	776.0067	776.0177	776.0177
Ø 2.4 mm	776.0063	776.0173	776.0173
Ø 3.2 mm	776.0064	776.0174	776.0174

		
Izolator / Inel adaptor	Standard (10 buc.)	pt. portelectrod cu lentila
Izolator	776.1043	776.0443
Inel adaptor	-	776.0441

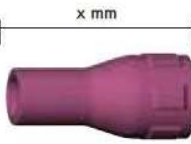
	
Lentila gaz	Lentila gaz
Ø 1.6 mm	775.0122
Ø 2.4 mm	775.0123
Ø 3.2 mm	775.0124

				
	26 mm	32 mm	x mm	50 mm
Duza gaz, Ceramica (10 buc.)	Standard	Bila	Standard x=36 mm x=60mm	Pentru difuzor gaz
Ø 6.5 mm	777.0081	770.0081.10	777.2171 777.2175	-
Ø 8.0 mm	777.0082	770.0082.10	777.2172 777.2176	-
Ø 10.0 mm	777.0083	770.0083.10	777.2173 -	-
Ø 11.5 mm	777.0084	770.0084.10	777.2174 -	-
Ø 12.5 mm	-	-	-	778.1183
Ø 16.0 mm	-	-	-	778.1184
Ø 19.5 mm	-	-	-	778.1188

WIG

Pistolete pentru sudare WIG tip "ABITIG® GRIP" racire aer si lichid



Sistemul de manere
ABITIG® GRIP – vezi
pag. 68-69.

- Pistolete pentru sudare WIG "ABITIG® GRIP"
- Maner cu comutator si functii de control – individual si ergonomic
- Articulație scurta cu bila pentru raza optima de indoire si manipulare usoara
- Pachet de furtune usor si flexibil, cu conectarea din partea spre masina, pentru toate tipurile uzuale de echipamente Wlg modulare
- reducerea costurilor cu depozitarea – numai 3 consumabile.

ABITIG® GRIP 200 / ABITIG® GRIP 200 F Date tehnice (EN 60 974-7):

Racire: aer
Curent: 200 A DC
140 A AC
D.A.: 35 %
Electrod: ø 1.6–3.2 mm

ABITIG® GRIP 450 W

Date tehnice (EN 60 974-7):

Racire: lichid*
Curent: 420 A DC / 400 A DC
300 A AC / 280 A AC
D.A.: 60 % / 100 %
Electrod: ø 1.6–4.8 mm

ABITIG® GRIP 450 W SC

Date tehnice (EN 60 974-7):

Racire: lichid*
Curent: 480 A DC / 450 A DC
340 A AC / 320 A AC
D.A.: 60 % / 100 %
Electrod: ø 1.6–4.8 mm

* Presiunea:
Min. 2.5 bar (max. 3.5 bar);
Debitul min. : 0.7 l/min.

Datele tehnice sunt caracteristice pistolotelor cu lungimea de 8,00 m.

Pistolet complet Tip	Racire	Nr. art.	Corp pistolot	
			Versiune	Nr. art.
ABITIG® GRIP 200	aer	vezi comentarii**	Standard	774.0010
ABITIG® GRIP 200 F	aer	vezi comentarii**	Flexibil	774.0130
ABITIG® GRIP 200 K	aer	vezi comentarii**	Scurt	774.0230
ABITIG® GRIP 450 W	lichid	vezi comentarii**	Standard	775.0010
ABITIG® GRIP 450 W K	lichid	vezi comentarii**	Scurt	775.0230

Corpul pistolotelui (standard si scurt) pentru ABITIG® GRIP 450 W sc este identic ca cel pentru ABITIG® GRIP 450 W.
Diferenta consta in constructia pachetului de furtune.

** datorita diferitelor tipuri de conexiuni la masina, nu putem preciza aici un numar de articol pentru pistolote. Va rugam consultati catalogul pistolote WIG complete existent in sectiunea download la adresa: www.binzel-abicor.ro.

ABITIG® GRIP 200, ABITIG® GRIP 450 W, ABITIG® GRIP 450 W SC

Consumabile



Capac	scurt	lung
	773.0053	773.0051



Portelectrod / Portelectrod cu lentila	Portelectrod (5 buc.)	Portelectrod cu lentila	Portelectrod cu lentila
Ø 1.6 mm	775.0062	773.0172	773.0172
Ø 2.0 mm	775.0067	773.0177	773.0177
Ø 2.4 mm	775.0063	773.0173	773.0173
Ø 3.2 mm	775.0064	773.0174	773.0174
Ø 4.0 mm	775.0065	773.0175	773.0175
Ø 4.8 mm	775.0066	773.0176	773.0176

WIG



Izolator	Standard	pt. portelectrod cu lentila
Izolator	775.1043	775.1143



Lentila gaz	Lentila gaz
Ø 1.6 mm	775.0122
Ø 2.4 mm	775.0123
Ø 3.2 mm	775.0124
Ø 4.0 mm	775.0125
Ø 4.8 mm	775.0126

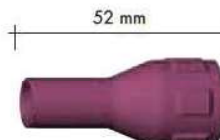

Duza gaz, Ceramica	Standard		Standard	pentru difuzor gaz
	x = 26 mm	x = 37 mm		
Ø 7.5 mm	-	775.0081	775.2171	-
Ø 10.0 mm	775.0152	775.0082	775.2172	-
Ø 12.0 mm	-	-	-	778.1183
Ø 13.0 mm	775.0153	775.0083	775.2173	-
Ø 13.0 mm (intarita)	-	775.0183	-	-
Ø 15.0 mm	-	775.0084	775.2174	-
Ø 15.0 mm (intarila)	-	775.0184	-	-
Ø 16.0 mm	-	-	-	778.1184
Ø 19.5 mm	-	-	-	778.1188